

- PRODESO® HEAT GRIP SYSTEM **NEW**
- PRODESO® HEAT/STICK SYSTEM
- PRODESO® DRAIN SYSTEM **NEW**
- PRODESO® MEMBRANE SYSTEM
- PRODESO® ECO/STICK SYSTEM **NEW**
- PRODESO® SOUND SYSTEM
- PROSHOWER SYSTEM
- PROFOIL SYSTEM
- PROFOIL PANEL SYSTEM
- PROGOBOARD PANEL SYSTEM
- PRODRAIN SYSTEM
- PROTERRACE SYSTEM
- PROLEVELING SYSTEM **NEW**
- PROLEVELING WEDGE SYSTEM **NEW**
- PROSUPPORT TUBE SYSTEM **NEW**
- PRORAIL SYSTEM **NEW**
- PROSUPPORT SLIM SYSTEM **NEW**
- PROLEDLIGHT SYSTEM
- PROMULTIFIX SYSTEM



## PROGRESS PROFILES SYSTEMS 2020/21

In sintonia con le esigenze del mercato e le più evolute tendenze dell'architettura contemporanea, Progress Profiles offre una sempre più vasta, completa ed innovativa scelta di sistemi per ottimizzare la posa e soddisfare, in un'unica soluzione, le specifiche esigenze funzionali ed estetiche di ogni tipologia di spazio residenziale o commerciale, interno ed esterno.

Frutto di un'intensa attività di ricerca e sviluppo, Progress Profiles Systems sono sistemi progettati nei minimi dettagli per proporsi come soluzioni creative, pratiche, veloci e, per la maggior parte, brevettate, che coniugano alta tecnologia, massima flessibilità e sicurezza con una particolare attenzione al design. Ogni elemento che compone il sistema gioca un ruolo fondamentale nel renderlo unico e performante per garantire una posa a regola d'arte che evolve con i nuovi stili di vita e un concetto di spazio mobile e dinamico.

*Progress Profiles, always connected and attuned with the market needs and the most advanced trends of the contemporary architecture, offers a more and more extensive, complete and innovative choice of systems to optimise the laying/fixing and meet all functional and aesthetic requirements of every residential, commercial or private environments, indoors or outdoors.*

*Progress Profiles Systems, as result of a research and development, are made to be creative, practical and quick solutions. Most of them are patented and combine high technology, the highest flexibility and safety with a special care of design. Every part of the system plays an essential function and makes it unique with high-performance to guarantee a workmanlike laying always abreast with the times.*



**PRODESO®  
HEAT GRIP  
SYSTEM**



**PRODESO®  
HEAT/STICK  
SYSTEM**



**PRODESO®  
DRAIN  
SYSTEM**



**PRODESO®  
MEMBRANE  
SYSTEM**



**PRODESO®  
ECO/STICK  
SYSTEM**

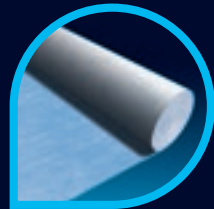

**PRODESO®  
SOUND  
SYSTEM**

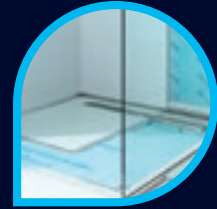

**PROSHOWER  
LINEAR  
SYSTEM**



**PROSHOWER  
CENTRAL  
SYSTEM**

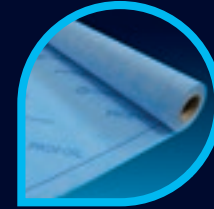

**PROFOIL  
SYSTEM**



**PROFOIL  
PANEL  
SYSTEM**



**PRO GOBOARD  
PANEL  
SYSTEM**

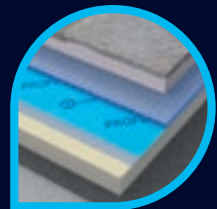

**PRODRAIN  
SYSTEM**



**PROTERRACE  
SYSTEM**

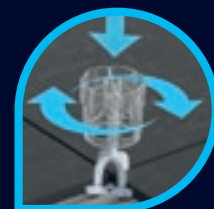

**PROLEVELING  
SYSTEM**



**PROLEVELING  
WEDGE  
SYSTEM**



**PROSUPPORT  
TUBE  
SYSTEM**



**PRORAIL  
SYSTEM**



**PROSUPPORT  
SLIM  
SYSTEM**

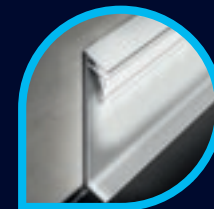

**PROLEDLIGHT  
SYSTEM**



**PROMULTIFIX  
SYSTEM**

**BREVETTATO  
PATENTED**

**NEW**



**BREVETTATO**

**PATENTED**

UA2016A002209  
EP 3 225 763 A1  
2696795  
CN 107268933 A  
US 9,726,383 B1  
US 10,502,434 B2  
US D818,615S  
US D818,616S  
US D818,617S  
US D832,467S  
US D841,837S  
US D872,901S  
CA 2,935,062  
DESIGN PATENT  
Patents Pending

**PRODESO® HEAT GRIP MEMBRANE**

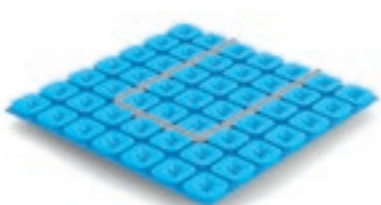

**PRODESO® HEAT GRIP CABLE**



**PRODESO® HEAT GRIP THERMOSTAT KIT**



**PRODESO® HEAT GRIP CABLE CLIP**

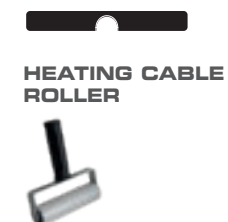

**PROECOFON**



# PRODESO® HEAT GRIP SYSTEM

**Una nuova evoluzione** nel segno della flessibilità, innovazione ed efficienza energetica.

Il sistema è costituito da tre elementi; **PRODESO HEAT GRIP MEMBRANE, PRODESO HEAT GRIP CABLE e PRODESO HEAT GRIP THERMOSTAT KIT**. La membrana in polietilene, con funzione desolidarizzante, impermeabilizzante e sfogo vapore, ha uno spessore di soli 8,5 mm ed è provvista inferiormente di un tessuto non tessuto in polipropilene termosaldato che ne garantisce il fissaggio al supporto.

La nuova geometria della membrana, oltre ad assicurare un perfetto ancoraggio del cavo scaldante, garantisce una resistenza allo strappo del pavimento 5 volte superiore rispetto al vecchio modello PRODESO HEAT. I cavi, di ultima generazione, sono formati da tante resistenze, lunghe 60 cm, montate in serie. In caso di danneggiamento del cavo quindi smette di funzionare la resistenza danneggiata e non l'intero cavo. Il termostato, di ultima generazione, si interfaccia con dispositivi Android ed Apple; ciò consente di programmare tutte le sue regolazioni ed impostazioni anche a distanza utilizzando una rete WiFi.

**A New evolution** with the goal of flexibility, innovation and energy efficiency

The system is composed of three elements: **PRODESO HEAT GRIP MEMBRANE, PRODESO HEAT GRIP CABLE e PRODESO HEAT GRIP THERMOSTAT KIT**. The polyethylene membrane with uncoupling, waterproofing and vapour management features has a 8,5 mm thickness and a thermowelded non-woven fabric on the back side, which guarantees the adhesion to the substrate.

The new membrane structure allows a perfect fixing of the heating cable and a crack-bridging ability 5 times more than the PRODESO HEAT. The cables of last generation are composed of many resistances, each one 60 cm long, in a parallel circuit. If the cable is damaged, only the broken resistance stops working but not the whole cable. The thermostat of last generation interfaces with Android and Apple devices, that is why it is possible to adjust all settings and time schedule using an application with internet connection as remote control.

## VANTAGGI

- Maggiore resistenza allo strappo
- Canali di sfogo vapore
- Nuovo cavo a potenza costante
- Termostato con controllo remoto

## ADVANTAGES

- Higher crack-bridging ability
- Vapour management ducts
- New constant power cable
- Remote controlled thermostat



DESOLIDARIZZAZIONE  
UNCOUPLING



IMPERMEABILIZZAZIONE  
WATERPROOFING



SFOGO VAPORE  
VAPOR AND MOISTURE  
MANAGEMENT

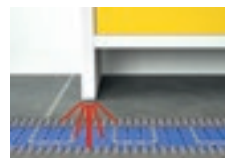

DISTRIBUZIONE DEL CARICO  
LOAD DISTRIBUTION

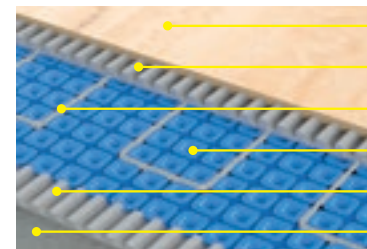

SEZIONE DI POSA / LAYING'S SECTION

- 1 Piastrelle in gres o pietre naturali  
Ceramic or porcelain tiles
- 2 Adesivo  
Thin-set / Adhesive
- 3 PRODESO® HEAT GRIP CABLE
- 4 PRODESO® HEAT GRIP MEMBRANE
- 5 Adesivo  
Thin-set / Adhesive
- 6 Massetto / multistrato / OSB  
Screed / plywood / OSB

**BREVETTATO  
PATENTED**



**BREVETTATO**

**PATENTED**

002748822  
EP 3 183 505 B1  
US 8,176,694 B2  
US 9,188,348 B2  
US 9,416,979 B2  
US 9,518,746 B2  
US 9,625,163 B2  
US 9,719,265 B2  
US 9,777,931 B2  
US 10,006,644 B2  
US 10,107,505 B2  
US 10,215,423 B2  
US 10,408,469 B2  
Patents Pending

# PRODESO® HEAT / STICK SYSTEM

## Un mondo di caldo benessere in accordo con la natura.

Il riscaldamento elettrico a pavimento e a rivestimento **PRODESO® HEAT SYSTEM**, ideato, realizzato e brevettato da Progress Profiles, è un sistema innovativo che consente di ottenere in breve tempo e a basso costo un ambiente piacevolmente caldo ed estremamente confortevole. Applicabile su ogni tipo di sottofondo grazie alle sue funzioni desolidarizzanti e impermeabilizzanti, consente di modulare la temperatura e i tempi di accensione; grazie un termostato di ultima generazione, garantisce una significativa ottimizzazione dei consumi. Facile e veloce da installare in qualsiasi condizione(\*), ha uno spessore complessivo di soli 5.5 mm, considerevolmente inferiore rispetto a qualsiasi altro sistema e non richiede alcuna manutenzione nel corso del tempo. Una tecnologia intelligente e una scelta responsabile che mette in primo piano i valori dell'ecosostenibilità e del risparmio energetico in sintonia con le tendenze dell'architettura contemporanea e della domotica più evoluta. Un mondo di caldo benessere in accordo con la natura.

(\*): disponibile anche nella versione auto-adesiva **PRODESO® HEAT STICK** per sottofondi in legno e ceramica.

## A World of warmth and comfort in respect with the nature.

Progress Profiles innovative and patented **PRODESO® HEAT SYSTEM** for electrical walls and floors heating ensures pleasant warm and comfortable environment with short laying times and at low cost. The system can be used on all kinds of substrate thanks to the membrane uncoupling and waterproofing properties. Temperature and operating times can be controlled from a latest generation thermostat that also guarantees significant savings in energy costs. The system is quick and easy to install in all conditions (\*) and has an overall thickness of only 5.5 mm, far thinner than any alternative system. It is also maintenance free over time. This smart, responsible technology supports the growing demand for sustainable solutions and energy saving while also satisfying the needs of contemporary architecture and evolved home automation. A world of natural, warm wellbeing.

(\*): available in the self-adhesive version **PRODESO® HEAT STICK** for wood and ceramic substrates.

### PRODESO® HEAT MEMBRANE

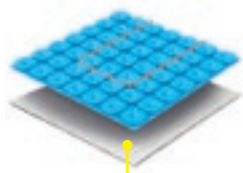

Tessuto in POLIPROPILENE (PP)  
Fabric POLYPROPYLENE (PP)

### PRODESO® HEAT THERMOSTAT KIT



DESOLIDARIZZAZIONE  
UNCOUPLING

### PRODESO® HEAT STICK MEMBRANE



### HEATING CABLE ROLLER



IMPERMEABILIZZAZIONE  
WATERPROOFING



SFGO VAPORE  
VAPOR AND MOISTURE MANA-  
GEMENT

### PRODESO® HEAT CABLE



### PRODESO® HEAT CABLE CLIP



### PROCOFON

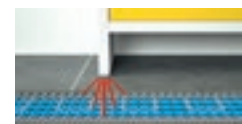

DISTRIBUZIONE DEL CARICO  
LOAD DISTRIBUTION

### SEZIONE DI POSA DI PRODESO® HEAT SYSTEM LAYING'S SECTION OF PRODESO® HEAT SYSTEM

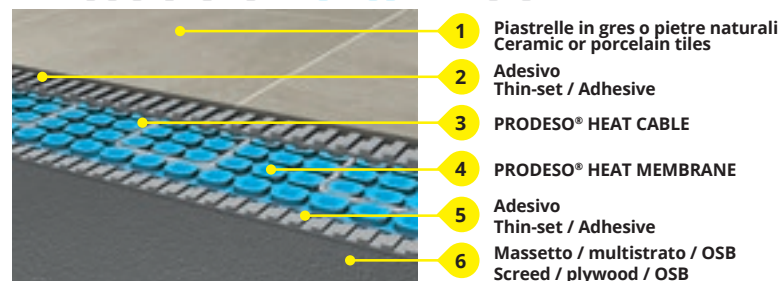

### SEZIONE DI POSA DI PRODESO® HEAT STICK SYSTEM LAYING'S SECTION OF PRODESO® HEAT STICK SYSTEM

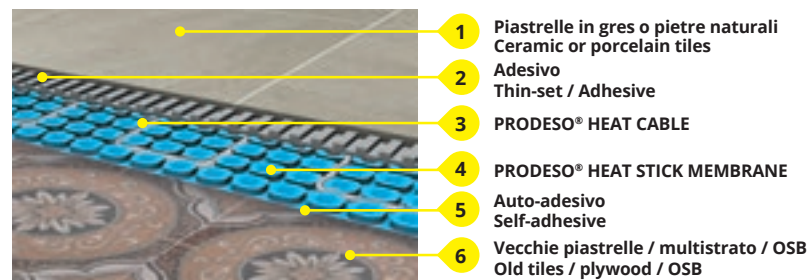

**BREVETTATO  
PATENTED**

**NEW**





# PRODESO® DRAIN SYSTEM

**Scopri il Prodeso Drain!!** L'indispensabile funzione drenante /impermeabilizzante garantita dal sistema più evoluto al mondo.

**PRODESO® DRAIN SYSTEM** è una membrana innovativa brevettata di ultima generazione, che consente di drenare ed impermeabilizzare il massetto garantendo un corretto e rapido asciugamento dell'adesivo sotto la piastrella, anche nel caso di grandi formati. La "camera d'aria" che viene a crearsi sotto la piastrella impedisce la risalita dei triacetati presenti negli adesivi, che altrimenti causerebbero la comparsa di efflorescenze nelle fughe. Il prodotto consiste di una lastra in polietilene ad alta densità, provvista di cavità tronco piramidali a base semicircolare, alla quale superiormente è termosaldato un tessuto drenante e inferiormente un tessuto non tessuto è incollato alla stessa. La grande innovazione, che consente di drenare e di impermeabilizzare con la stessa membrana, è la bandella che sporge lateralmente resa adesiva con uno strato di butile. Nello specifico la bandella perimetrale è adesiva per metà altezza e quella frontale è adesiva su tutta altezza. Le proprietà desolidarizzanti e di sfogo vapore di **PRODESO® DRAIN** consentono la sua posa anche su supporti non perfettamente stagionati. Semplice e veloce da installare, ha uno spessore complessivo di soli 5 mm, di gran lunga inferiore rispetto a qualsiasi altro sistema, e non richiede l'utilizzo di adesivi particolari. La versatilità è una qualità fondamentale di questo prodotto: sapientemente ricercata per far sì che possa isolare e facilitare la posa delle piastrelle sia negli ambienti esterni che anche nelle zone umide interne: quali centri benessere SPA o piscine interne. Una tecnologia intelligente ed innovativa che si coniuga perfettamente con la semplicità, la rapidità e l'efficacia di posa.

**Discover Prodeso Drain!!** With its essential draining/waterproofing function guaranteed by the most advanced system in the world

**PRODESO® DRAIN SYSTEM** is an innovative and patented membrane of last generation for the screed draining and waterproofing to guarantee a correct and quick drying of the adhesive under the tile in case of large sizes too. The "inner room" drying and drainage area which is created under the tile prevents the rise of triacetates present in the adhesives, which otherwise would cause the appearance of efflorescence in the joints. The product consists of a high density polyethylene sheet, with semicircular truncated pyramidal cavities, to which is thermo-welded a draining fabric above and, below, it is thermo-glued a non-woven fabric.

The great innovation, which allows to drain and waterproof with the same membrane, is the tape with adhesive butyl sheet that protrudes laterally. The perimeter tape is adhesive for half height and its front side is adhesive on the whole height.

**PRODESO® DRAIN** uncoupling and vapour management features allow its application on not perfectly cured substrates. Easy and quick to install, it has an overall thickness of only 5 mm, less than any other system and does not require the use of special adhesives. Versatility is an essential quality of this product: made to ensure the insulation and make the laying of tiles easy both outdoor and in indoor humid areas too: such as SPA spas or indoor pools.

An innovative technology that perfectly combines with a simplicity, speed and effectiveness of installation.

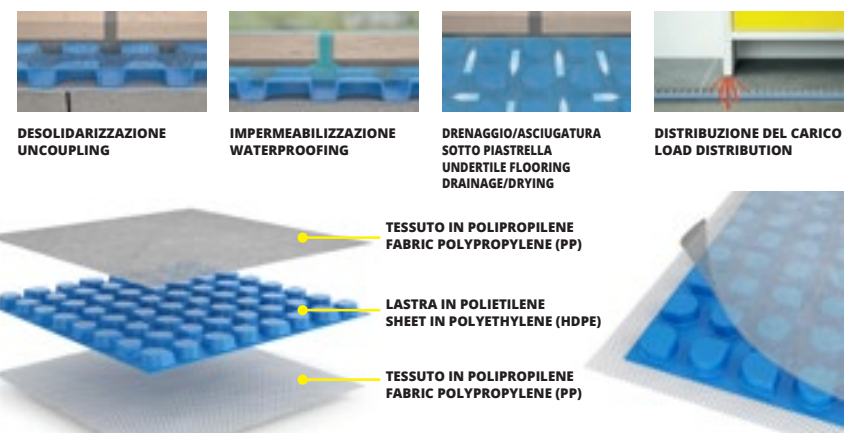
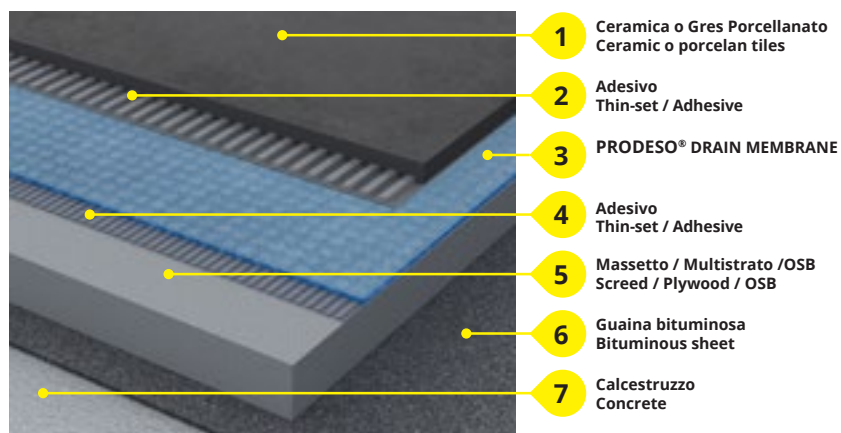

**BREVETTATO  
PATENTED**



# PRODESO® MEMBRANE SYSTEM

**Massima flessibilità, protezione, sicurezza, all'interno ed all'esterno.**

**PRODESO® MEMBRANE SYSTEM** è un sistema desolidarizzante ed impermeabilizzante per supporti problematici, terrazzi, balconi e superfici orizzontali di qualsiasi dimensione. Grazie a PRODESO® MEMBRANE SYSTEM è possibile non realizzare i giunti di frazionamento nel massetto e se sono presenti di non rispettarli durante la posa di ceramica e pietre naturali. Molti sono i vantaggi offerti dal sistema, progettato da Progress Profiles, che garantisce la massima flessibilità di posa, protezione del pavimento e garanzia nel tempo dentro e fuori casa.

**Velocità:** riduce drasticamente i tempi di cantiere visto che dalla posa della membrana sino alla posa della pavimentazione è possibile lavorare senza interruzioni.

**Versatilità:** garantisce la posa su qualsiasi supporto anche di grandissima dimensione sia all'interno che all'esterno.

**Impermeabilità:** garantisce l'impermeabilizzazione del sottofondo anche in caso di sovrapposizione, su supporti fessurati e non perfettamente stagionati e quindi con possibili tensioni di vapore.

**Maximum flexibility, protection, safety, indoors and outdoors.**

**PRODESO® MEMBRANE SYSTEM** is an uncoupling and waterproofing system for problematic substrates, balconies, terraces and horizontal surfaces of any dimension. Thanks PRODESO® MEMBRANE SYSTEM is possible not to make fractional/expansion joints in the screed before the laying of tiles and natural stones, if the screed has already been cut it is possible to lay the tiles on the existing joints. There are many advantages to use the system of Progress Profiles, which gives the utmost laying flexibility, floor protection and long-time guarantee indoors and outdoors.

**Time saving:** installation time are drastically reduced. Membrane, tile installation and grouting can be completed in the same day.

**Versatile:** it can be used on any supports, both indoor and outdoor.

**Waterproofing:** it guarantees the laying of any floor and the waterproofing of the substrate in overlapping too, or for cracked and not perfectly cured supports with possible vapour pressure.

PRODESO® MEMBRANE



PROBAND 150



RULLO PRESSORE ROLLER



PROBAND KOLL



PROBAND KOLL AB



PROBAND BU



ANGOLI PREFORMATI WELDED CORNERS



DESOLIDARIZZAZIONE UNCOUPLING



IMPERMEABILIZZAZIONE WATERPROOFING



SFOGO VAPORE VAPOR AND MOISTURE MANAGEMENT



DISTRIBUZIONE DEL CALORE FLOOR HEATING DISTRIBUTION



DISTRIBUZIONE DEL CARICO LOAD DISTRIBUTION

SEZIONE DI POSA DI PRODESO® MEMBRANE SYSTEM LAYING'S SECTION OF PRODESO® MEMBRANE SYSTEM

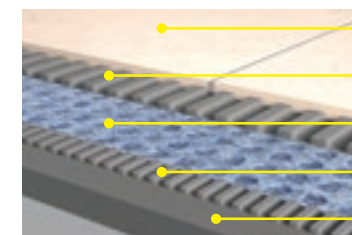

- 1 Ceramica o Gres Porcellanato  
Ceramic or porcelain tiles
- 2 Adesivo  
Thin-set / Adhesive
- 3 PRODESO® MEMBRANE
- 4 Adesivo  
Thin-set / Adhesive
- 5 Massetto / multistrato / OSB  
Screed / Plywood / OSB

BREVETTATO

PATENTED

003368984



# PRODESO® ECO / STICK SYSTEM

## Per ogni supporto la giusta posa

La membrana che risolve ogni problematica di superficie.

**PRODESO® ECO** è una membrana desolidarizzante ed impermeabilizzante per sottofondi problematici e superfici orizzontali di qualsiasi dimensione senza giunti di frazionamento nel massetto prima della posa di ceramica e pietre naturali. Garantisce la posa di qualsiasi pavimentazione anche in caso di supporti fessurati e non perfettamente stagionati e quindi con possibili tensioni di vapore e in caso di sovrapposizione. È una membrana in polietilene ad elevata densità provvista di cavità quadrate sagomate a coda di rondine, termosaldata inferiormente ad un tessuto non tessuto in polipropilene che garantisce l'adesione al supporto (\*).

(\*): disponibile anche la versione auto-adesiva **PRODESO® ECO STICK** per supporti in legno e ceramica.

### PRODESO® ECO MEMBRANE

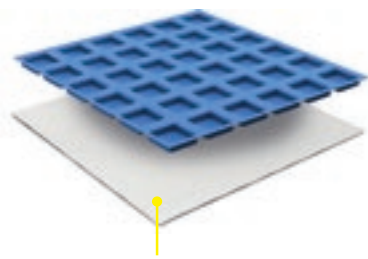

Tessuto in POLIPROPILENE (PP)  
Fabric POLYPROPYLENE (PP)

### PRODESO® ECO STICK MEMBRANE

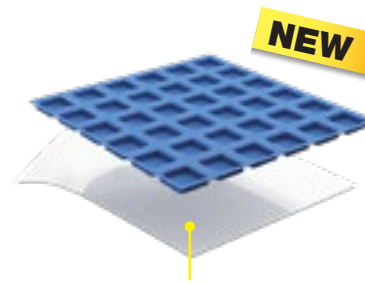

Auto-adesivo  
Self-adhesive



DESOLIDARIZZAZIONE  
UNCOUPLING



IMPERMEABILIZZAZIONE  
WATERPROOFING



SFOGO VAPORE  
VAPOR AND  
MOISTURE  
MANAGEMENT



DISTRIBUZIONE  
DEL CALORE  
FLOOR HEATING  
DISTRIBUTION

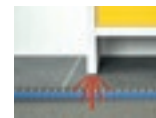

DISTRIBUZIONE  
DEL CARICO  
LOAD DISTRIBUTION

## The right flooring for every surface

The membrane that solves any problem on every surface

**PRODESO® ECO** is an uncoupling and waterproofing membrane for problematic supports and horizontal surface of any size that does not require expansion joints in the screed before laying ceramic and natural stone tiles. **PRODESO® ECO** ensures the laying of every flooring also in case of cracked and not perfectly cured substrates and therefore with possible vapor pressure and in case of old tiles. Membrane in high density polyethylene provided with a grid structure of square cavities, each cut back in a dovetail configuration. On the back side it is provided with a non-woven thermo-welded polypropylene fabric that guarantees the adhesion with the adhesive(\*).

(\*): available in the self-adhesive version **PRODESO® ECO STICK** for wood and ceramic substrates.

### SEZIONE DI POSA DI PRODESO® ECO SYSTEM LAYING'S SECTION OF PRODESO® ECO SYSTEM

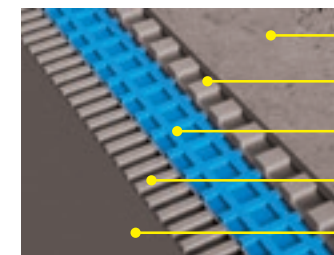

- 1 Piastrelle in gres o pietre naturali  
Ceramic or porcelain tiles
- 2 Adesivo  
Thin-set / Adhesive
- 3 PRODESO® ECO MEMBRANE
- 4 Adesivo  
Thin-set / Adhesive
- 5 Massetto / multistrato / OSB  
Screed / plywood / OSB

### SEZIONE DI POSA DI PRODESO® ECO STICK SYSTEM LAYING'S SECTION OF PRODESO® ECO STICK SYSTEM

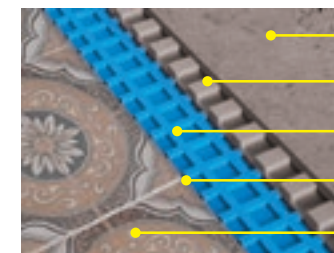

- 1 Piastrelle in gres o pietre naturali  
Ceramic or porcelain tiles
- 2 Adesivo  
Thin-set / Adhesive
- 3 PRODESO® ECO STICK MEMBRANE
- 4 Auto-adesivo  
Self-adhesive
- 5 Vecchie piastrelle / multistrato / OSB  
Old tiles / plywood / OSB



**SOUND PROOF  
REDUCTION**

**VELOCITÀ:**  
riduce drasticamente i tempi di cantiere visto che dalla posa della membrana sino alla posa della pavimentazione è possibile lavorare senza interruzioni.

**SPEED:**  
drastically reduces renovation times; since the installation of the membrane until the laying of the flooring it is possible to work without interruption.

**VERSATILITÀ:**  
garantisce la posa su qualsiasi supporto anche di grandissima dimensione.

**VERSATILITY:**  
guarantees installation on any support, even of very big size.

**FONOASSORBENZA:**  
in soli 3 mm si ottiene un abbattimento acustico molto elevato.

**SOUNDPROOFING:**  
in just 3 mm, a very high noise reduction is achieved.



# PRODESO® SOUND SYSTEM

## Massimo comfort abitativo.

**PRODESO® SOUND SYSTEM** è una membrana desolidarizzante e fonoassorbente da applicare sotto la piastrella, che consente di abbattere di 17 Db l'onda acustica da calpestio. Grazie alla caratteristica desolidarizzante di PRODESO® SOUND SYSTEM è possibile ristrutturare abitazioni senza dover demolire la vecchia pavimentazione; è infatti sufficiente incollare la membrana sul vecchio pavimento e direttamente su di essa la nuova pavimentazione senza essere obbligati a rispettare eventuali giunti di frazionamento presenti. Molti sono i vantaggi offerti dal sistema, progettato da Progress Profiles, che garantisce la massima flessibilità di posa, protezione del pavimento e garanzia nel tempo.

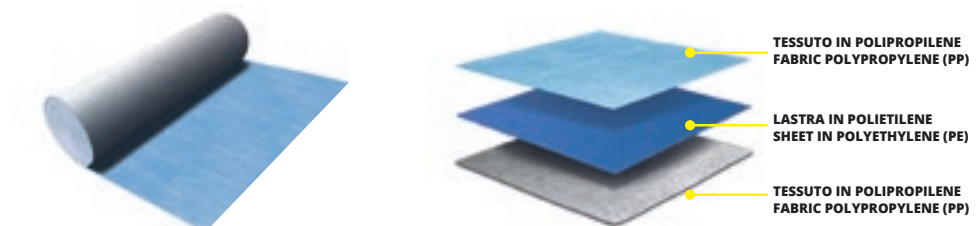

SEZIONE DI POSA DI PRODESO® SOUND SYSTEM  
LAYING'S SECTION OF PRODESO® SOUND SYSTEM



## Maximum living comfort.

**PRODESO® SOUND SYSTEM** is an uncoupling and sound-proofing membrane to be applied under the tile, which reduces of 17 Db the acoustic wave produced by footsteps. Thanks to its uncoupling function with PRODESO® SOUND SYSTEM it is possible the renovation of houses without removing the old flooring; it is enough to glue the membrane on the old flooring and directly on it, the new one, without being obliged to respect any expansion joints. The system, designed by Progress Profiles, offers a lot of advantages which guarantee maximum installation flexibility and protection of the flooring over time.



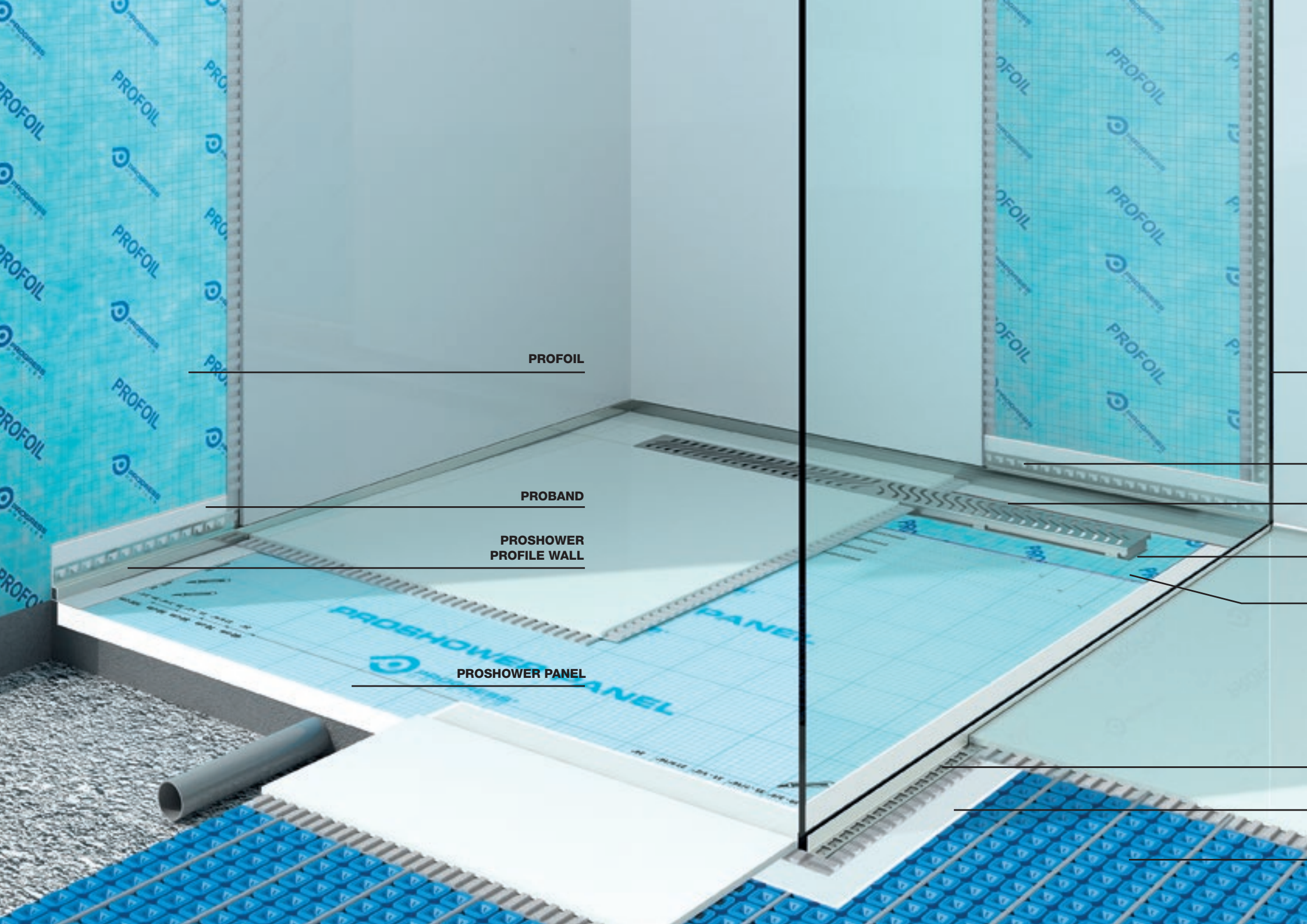

**PROFOIL**

**PROBAND**

**PROSHOWER  
PROFILE WALL**

**PROSHOWER PANEL**



# PROSHOWER LINEAR SYSTEM

## Il sistema che rivoluziona l'ambiente doccia.

**Sistema innovativo che coniuga funzionalità e design per soddisfare, con un'ampia e versatile gamma di soluzioni, ogni specifica esigenza in fatto di "ambiente doccia".**

Pratico, veloce e in sintonia con i moderni stili d'arredo, si compone di elementi e finiture di primissima qualità: la membrana PROFOIL, per una corretta impermeabilizzazione semplice e duratura; il piatto doccia PROSHOWER PANEL che garantisce una perfetta pendenza e riduce i tempi di posa; i profili della linea PROSHOWER PROFILE che completano il perimetro del piatto doccia e sostengono una eventuale lastra in vetro. Infine lo scarico PROSHOWER BASE L / BASIC, disponibile in più lunghezze e con diverse griglie di finitura in acciaio inox, per donare un tocco di design contemporaneo.

## The innovative system for the shower.

**PROSHOWER SYSTEM is an innovative system that combines functionality and design to provide a wide range of solutions for your next shower project.**

Modern design styling, easy installation techniques it includes: PROFOIL waterproofing membrane, for an easy and lasting waterproofing; PROSHOWER PANEL waterproof shower base which guarantees a perfect slope and reduces the working time; the profiles of PROSHOWER PROFILE LINE to finish the outer edge of the shower tray and hold the shower glass, last but not least PROSHOWER BASE / BASIC available in many sizes and with several grids in stainless steel of contemporary design.

PROLISTEL CHANNEL

PROSHOWER PROFILE FRONT

PROSHOWER TOP

PROSHOWER BASE L  
PROSHOWER BASE BASIC

TASSELLO PROFOIL  
PROFOIL SECTION

PROSHOWER PROFILE GLASS

PROBAND

PRODESO HEAT GRIP SYSTEM

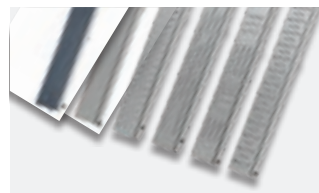

PROSHOWER TOP



PROSHOWER BASE L/BASIC



PROSHOWER PANEL



PROLISTEL CHANNEL



PROSHOWER PROFILE GLASS



PROSHOWER PROFILE WALL



PROSHOWER PROFILE FRONT



PROSHOWER PROFILE



PROFOIL



PROBAND 150

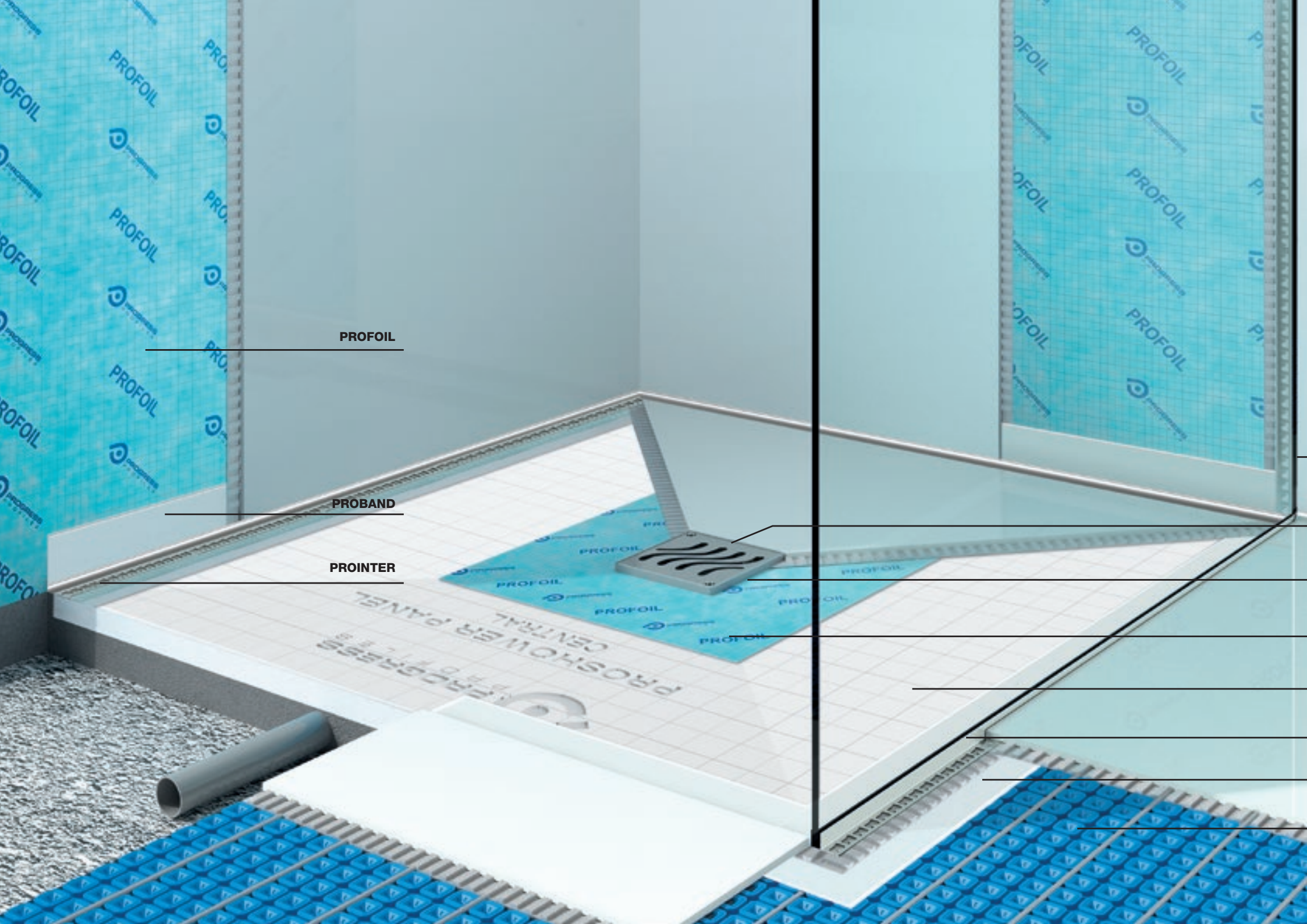

PROFOIL

PROBAND

PRINTER

# PROSHOWER CENTRAL SYSTEM

## Il sistema che rivoluziona l'ambiente doccia.

Sistema innovativo che coniuga funzionalità e design per soddisfare, con un'ampia e versatile gamma di soluzioni, ogni specifica esigenza in fatto di "ambiente doccia".

Pratico, veloce e in sintonia con i moderni stili d'arredo, si compone di elementi di primissima qualità: la membrana PROFOIL, per una corretta impermeabilizzazione semplice e duratura; il piatto doccia PROSHOWER PANEL CENTRAL che garantisce una perfetta pendenza e riduce i tempi di posa; infine il PROSHOWER DRAIN LATERAL KIT e PROSHOWER DRAIN VERTICAL KIT completi di griglia in acciaio inox 10 x 10 cm, per donare un tocco di design contemporaneo.

## The innovative system for the shower.

PROSHOWER SYSTEM is an innovative system that combines functionality and design to provide a wide range of solutions for your next shower project.

Modern design styling, easy installation techniques it includes: PROFOIL waterproofing membrane, for an easy and lasting waterproofing; PROSHOWER PANEL CENTRAL which guarantees a perfect slope and reduces the working time; the profiles to finish the outer edge of the shower tray and hold the shower glass, last but not least PROSHOWER DRAIN LATERAL KIT and PROSHOWER DRAIN VERTICAL KIT completed with a 10 x 10 stainless steel grid to give contemporary design.

PROLISTEL CHANNEL

PROSHOWER DRAIN GRIGLIA

PROSHOWER DRAIN LATERAL

TASSELLO PROFOIL PROFOIL SECTION

PROSHOWER PANEL CENTRAL

PROLISTEL CHANNEL

PROBAND

PRODESO HEAT GRIP SYSTEM



PROSHOWER PANEL CENTRAL



PROLISTEL CHANNEL



PRINTER



PROFOIL



PROBAND 150



PROBAND FIX

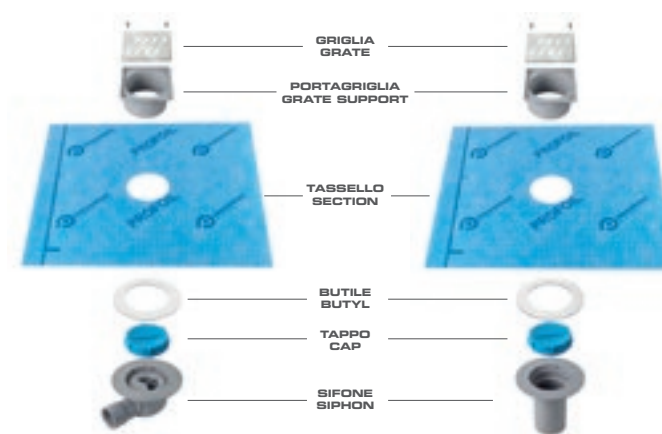

PROSHOWER DRAIN LATERAL/VERTICAL KIT



# PROFOIL SYSTEM

## Il sistema completo di impermeabilizzazione

**PROFOIL SYSTEM** si compone di diversi elementi.

**PROFOIL:** membrana impermeabilizzante in polietilene provvista su ambo i lati di tessuto non tessuto in polipropilene termosaldato che garantisce una elevata adesione al supporto.

**PROFOIL PASTE:** guaina elastica a strato sottile, con una elevata lavorabilità ed idrofobicità, rapida e pronta all'uso da utilizzare per impermeabilizzare strutture curve e nicchie ove l'applicazione della membrana PROFOIL risulterebbe complicata.

**PROBAND FIX:** sigillante monocomponente igroindurente a base di polimeri silano terminali per la sigillatura impermeabile di rotoli adiacenti di PROFOIL con PROBAND 150.

**PROBAND 150:** nastro impermeabile in polietilene provvisto su ambo i lati di tessuto non tessuto in polipropilene che garantisce il suo incollaggio.

Con PROFOIL SYSTEM, completo di tutti i pezzi speciali quali l'angolo interno, esterno ed il tassello di tenuta è possibile impermeabilizzare ambienti a contatto diretto o occasionale con acqua quali piscine, bagni e cucine, e con elevata tensione di vapore quali saune e centri wellness.

### ANGOLI PREFORMATI e TASSELLO DI TENUTA WELDED CORNERS AND PIPE COLLAR



SPATOLA  
TROWEL

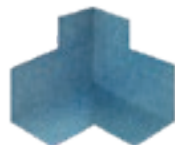

PROFOIL PASTE

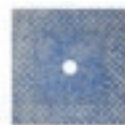

PROBAND FIX



### PROBAND 150

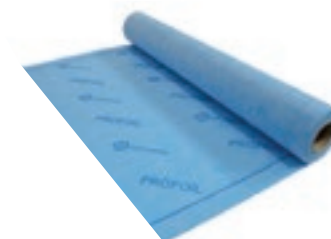

## The complete waterproofing system

**PROFOIL SYSTEM** is composed of several elements.

**PROFOIL:** waterproofing membrane in polyethylene provided on both sides with non-woven polypropylene thermo-welded fabric that guarantees a high adhesion to the support.

**PROFOIL PASTE:** thin-layer elastic membrane, with a high workability and hydrophobicity, quick and ready to use. It is suitable to waterproof curved structures and niches where the application of the PROFOIL membrane would be difficult.

**PROBAND FIX:** single component, moisture-curing sealant with silane polymers to waterproof adjacent rolls of PROFOIL using PROBAND 150.

**PROBAND 150:** waterproof tape in polyethylene provided on both sides with non-woven polypropylene fabric that guarantees its bonding.

With PROFOIL SYSTEM, complete with all special pieces as the internal and external corner and the sealing dowel it is possible to waterproof environments in direct or occasional contact with water such as pools, bathrooms and kitchens, and with high vapour pressure such as saunas and wellness centres.



# PROFOIL PANEL SYSTEM

**Un prodotto e tante soluzioni**  
per una posa creativa, pratica e veloce.

**PROFOIL PANEL** sono pannelli in polistirene estruso con una densità di 48 kg/m<sup>3</sup>, rivestiti su entrambi i lati con una membrana impermeabile all'acqua e al vapore. I pannelli, idonei per applicazioni interne, sono irrigiditi, oltre che dalla membrana impermeabile, dall'adesivo utilizzato per il suo fissaggio e sono progettati e testati per la resistenza e la durata nel tempo. Per tale motivo sono quindi idonei come supporto per la posa di piastrelle, per impermeabilizzare e per realizzare strutture e pareti portanti. I pannelli sono disponibili con uno spessore di 6.35 / 9.5 / 12.7 / 15.9 / 25 / 38,1 e 50,8 mm e una dimensione di 91,5 x 152.4 / 270 cm. PROFOIL PANEL, che consente di realizzare il lavoro in modo rapido ed economico, è idoneo in ambienti interni con funzione termoisolante a pavimento, rivestimento e soffitto. I pannelli possono essere applicati su muri grezzi, su vecchi sottofondi e pavimenti, su strutture fisse in legno e metallo, per la realizzazione di pareti divisorie, top per cucine, lavabi mensole e mobili di vario tipo.

**One product and many solutions** for a creative, practical and fast installation.

**PROFOIL PANEL** is a range of panels in extruded polystyrene with a density of 48 kg/m<sup>3</sup>. They are covered on both sides with a water and vapour-proof membrane. The panels, suitable for indoor applications, are stiffened, by the waterproof membranes and the adhesive used for their fixing. The panels are designed and tested to have mechanical resistance and long durability. For this reason they are therefore suitable as support for laying the tiles, to waterproof and create structures and load-bearing walls. The panels are available in a thickness of 6.35 / 9.5 / 12.7 / 15.9 / 25 / 38.1 and 50.8 mm and a size of 91.5 cm x 152.4 cm / 270 cm. PROFOIL PANEL, which allows the work to be carried out quickly and inexpensively, is suitable for indoor application with a thermal insulation function on floor, wall and ceiling. The panels can be applied on rough walls, on old supports and floors, on fixed structures in wood and metal, for the realization of partitions walls, tops for kitchens, washbasins, shelves and furniture of different types.

## ESEMPI DI APPLICAZIONI PER I DIVERSI SPessori / EXAMPLES OF APPLICATIONS FOR DIFFERENT THICKNESSES:



Spessore / Thickness 6, 9 mm



Spessore / Thickness 12, 16, 25 mm



Spessore / Thickness 25, 38, 50 mm



**PROFOIL TASSELLI**  
**PROFOIL DOWELS**



**PROFOIL RONDELLE**  
**PROFOIL WASHERS**  
(metallo zincato / zinc-coated metal)



**PROBAND NET**



**PROBAND 150**



**PROBAND FIX**



**PROFOIL VITI** (metallo zincato)  
**PROFOIL SCREWS** (zinc-coated metal)



## PROFOIL PANEL NICHE

PFLPANICH 88

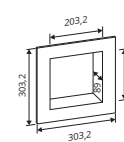

PFLPANICH 1212

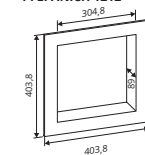

PFLPANICH 821

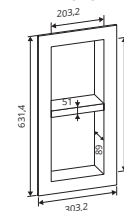

PFLPANICH 1221

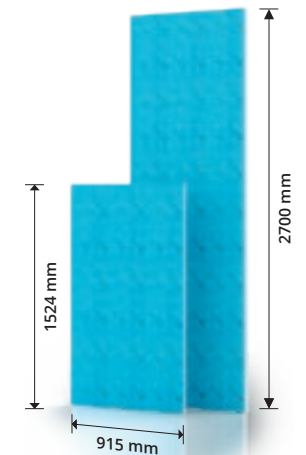
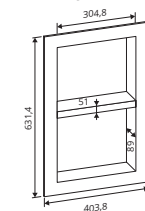

Temporaneamente non vendibile in Germania  
Temporarily not salable in Germany



GoBoard  
Johns Manville

GoBoard  
Johns Manville



GoBoard  
Johns Manville

Replace the Backer Board

Durable, Lightweight, Water-proof Tile Backer Board

Durable, Lightweight



Floors & Co

GoBoard  
Johns Manville

GoBoard  
Johns Manville



# PROGOBOARD PANEL SYSTEM

## Alta impermeabilità e resistenza per la massima versatilità di posa

**PRO GOBOARD PANEL** sono pannelli in poliisocianurato espanso ad alta densità rivestito su entrambi i lati da una impermeabilizzazione cementizia rinforzata con una rete in fibra di vetro, che garantisce la posa delle piastrelle. I pannelli, di dimensione 92 x 152 cm e 122 x 244 cm, sono disponibili con uno spessore di 6, 12, 25, 50 mm e possono essere posati, sia all'interno che all'esterno, a pavimento, parete e a soffitto.

## The best waterproofing and resistance for the best tile fixing.

**PRO GOBOARD PANEL** is a range of high density polyisocyanurate foam panel, covered on both sides with a fibre-glass reinforced cement-based waterproof coating to allow the laying of tiles. The panels, tested for a resistance long duration, are available in thickness of 6.25/12.5/25 and 50 mm, size of 91.5x152.5 cm and can be used on floors, false ceilings, walls, showers and ceilings.

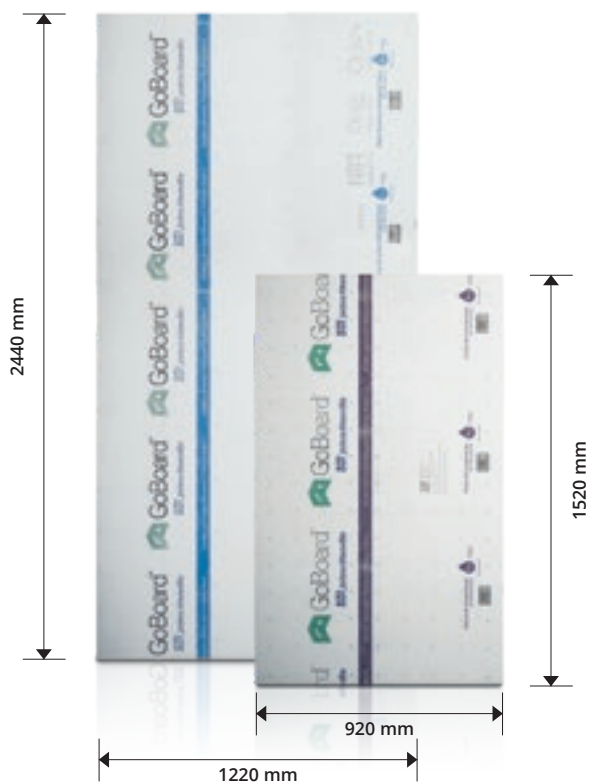

Non vendibile in Nord America / Not for sale in North America



# PRODRAIN SYSTEM

**Il sistema di drenaggio** garantito.

The guaranteed **drainage system**.

**PRODRAIN 10** è una membrana drenante costituita da una lastra in polietilene ad alta densità (HDPE) di colore blu provvista di rilievi tronco conici a basi circolari, sormontati da un tessuto non tessuto in polipropilene termosaldato permeabile all'acqua. La membrana ha una elevata resistenza alle soluzioni saline, acide, alcaline, all'alcool e agli oli.

Con PRODRAIN è possibile realizzare:

**Drenaggio sotto massetto:** quando si posano i pavimenti a malta quali porfidi e quarziti si prevengono le efflorescenze e rotture legate alla presenza di acqua nel massetto.

**Protezione dell'impermeabilizzazione:** protegge la guaina bituminosa dal contatto diretto con il massetto garantendo maggior durabilità al sistema.

**Previene risalite capillari:** applicata ruotata di 180° sotto il massetto (lastra blu in alto) previene la risalita capillare creando una intercapedine d'aria di 1 centimetro.

**PRODRAIN 10** is a draining membrane composed of a blue high-density polyethylene (HDPE) sheet provided with truncated conical reliefs with circular bases, surmounted by a non-woven polypropylene thermo-welded fabric permeable to water. The membrane has a high resistance to saline, acid, alkaline, alcohol and oil solutions. It is possible to use PRODRAIN:

**To drain the screed:** to prevent efflorescence and breakage due to water in the screed when mortar floors such as porphyry and quartzite are laid.

**To protect the waterproof membrane:** it is possible to protect the waterproof sheet from direct contact with the screed, ensuring greater durability to the system.

**To stop capillary risen:** the membrane overturned of 180° laid under the screed (blue sheet at the top) creates an air cavity that prevents the water capillary movement.

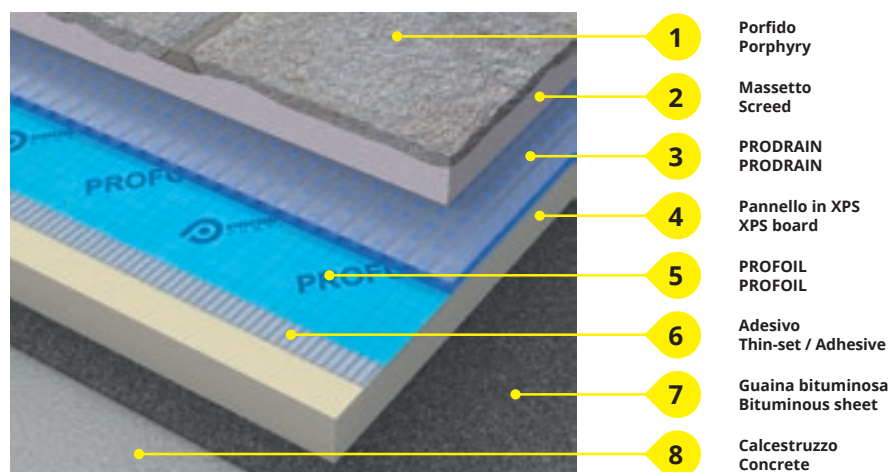

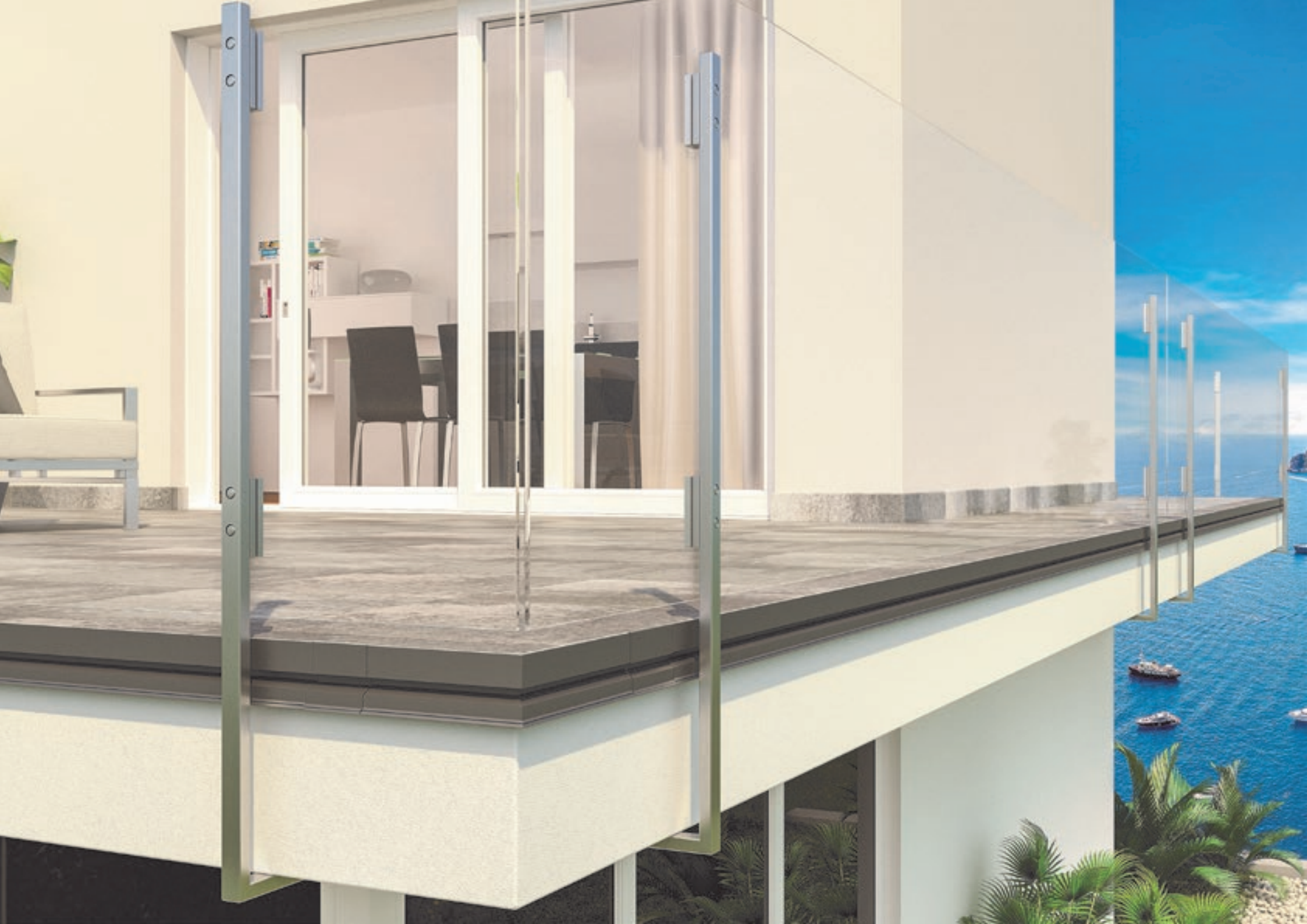

# PROTERRACE SYSTEM

## Esterni d'Autore. Protegge, valorizza.

Innovativo sistema per terrazzi e balconi, **PROTERRACE SYSTEM** è stato studiato da Progress Profiles per proteggere i bordi delle piastrelle, il massetto da filtrazioni d'acqua e per consentire un corretto deflusso delle acque. Una gamma completa e articolata di profili perimetrali multi-funzionali, in alluminio verniciato, nelle tonalità bianco, grigio, grigio antracite, testa di moro, corten e a richiesta beige e acciaio inox, che sostituiscono gli elementi ad "L" in ceramica e i gocciolatoi in marmo. I profili sono muniti di un'aletta di ancoraggio traforata, che ne garantisce una perfetta presa con il supporto, di una sezione verticale che protegge il massetto da infiltrazioni d'acqua e copre il bordo della pavimentazione, nonché di rompi-goccia innovativo e fori ad asola che consentono la fuoriuscita di acqua filtrata tra profilo e piastrella (versione "Drain"). Un sistema d'eccellenza per valorizzare e proteggere esterni di qualità e restituirne piena vivibilità, in ideale continuità con gli ambienti interni.

## Exterior finishing details. It protects and enhances.

**PROTERRACE SYSTEM** is an innovative system for terraces and balconies projected by Progress Profiles to protect the edges of the tiles, the screed from water infiltrations and to allow a correct outflow of water. A complete and articulated range of multi-functional perimeter profiles, in powder varnished aluminium, in the shades white, gray, anthracite gray, dark brown, corten (on request beige) and stainless steel, which replace the ceramic "L corner pieces" and the thresholds in marble. The profiles are equipped with a punched flange, which guarantees a perfect grip with the adhesive, a vertical side that protects the screed from water infiltration and covers the edge of the flooring. The Drain version is completed with an innovative drip-guard and holes that allow the outflow of infiltrated water between profile and tiles. A system of excellence to enhance and protect exterior environments and restore full liveability, in ideal continuity with the interiors.

### GAMMA COLORI GOFFRATI / EMBOSSED COLOURS

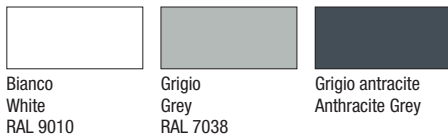

### GOFFRATI A RICHIESTA / EMBOSSED ON DEMAND

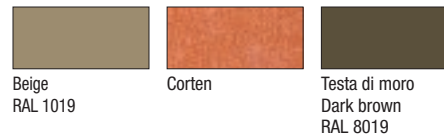

### SEMILUCIDI A RICHIESTA / SEMIGLOSSY ON DEMAND

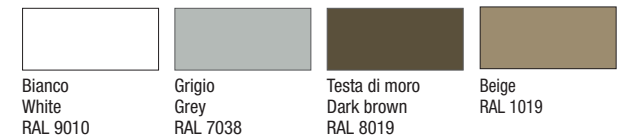

PROTERRACE  
DRAIN DRIP



PROTERRACE  
ECO DRIP



PROTERRACE  
DRAIN FDP



PROTERRACE  
PCG



PROTERRACE  
PCJ



PROTERRACE  
ECJ



PROTERRACE  
PC



PROTERRACE  
PTER

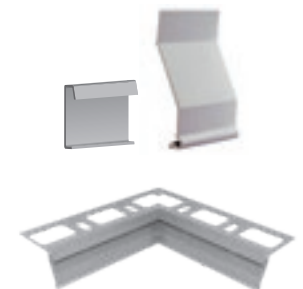

ANGOLI ESTERNI / INTERNI E GIUNZIONI  
EXTERNAL / INTERNAL CORNERS AND JOINTS

**Il solo con 2 elementi**

The only one with 2 elements

**BREVETTATO  
PATENTED**

**Risparmio 3 pezzi negli incroci**

Save 3 pieces on intersections

**Perfetta visibilità delle fughe**

Completley visible joint

**BREVETTATO**

**PATENTED**

1407796  
1424326  
EP 2573296 B1  
EP 2952652 A1

# PROLEVELING SYSTEM

## Massima trasparenza per una posa perfetta.

**PROLEVELING SYSTEM** è un sistema rivoluzionario ed innovativo che rende semplice e rapida la posa con solo 2 elementi (livellatore e tirante). Una gamma completa di livellatori a croce, T e lineari da 1, 2, 3 e 5 mm per pavimenti e rivestimenti da 3 a 40 mm di spessore. I livellatori a T e a croce, di colore bianco, e lineari di colore azzurro chiaro, sono provvisti di un perno filettato che consente la rotazione del tirante. Il tirante, in polietilene trasparente, è provvisto di una serie di fori che permettono all'utilizzatore di verificare l'allineamento delle piastrelle e l'uniformità delle fughe. Il sistema si completa con:

**PROTECTION CAP:** protegge da graffi le pavimentazioni delicate quali marmi, pietre naturali e porcellanati lappati dall'azione rotante del tirante.

**SVITATORE:** consente di rimuovere in modo pratico e veloce, i livellatori rotti dal tirante utilizzando un comune trapano.

**PROLEVELING WEDGE SYSTEM:** il sistema di livellamento a cunei migliorato nell'efficienza, nell'ergonomia e nel rispetto della normativa che, grazie alle alette direttamente fissate sulla base.

**MULTISPACER:** distanziatore brevettato multi spessore soprapiastriglia riutilizzabile con funzione di posa a Croce, T e lineare in un unico prodotto.

### PROLEVELLING SYSTEM



## Transparency for a perfect laying.

**PROLEVELING SYSTEM** is a revolutionary and innovative system to make the laying easy and quick only with two elements (leveller and tie-rod). A complete range of levellers in form of cross, T and linear of 1, 2, 3 and 5 mm, for floor and wall with thickness from 3 to 40 mm.

The white levellers in form of T and cross, and the light blue linear levellers have a threaded pin where the tie rod should be screwed. The tie rod in transparent polyethylene has holes to check if tiles and joints are aligned.

Other parts of the system are:

**PROTECTION CAP:** to protect the surface of floors as marbles, natural stones and polished porcelain tiles from possible scratches due to the tie rod rotation.

**UNSCREWING DEVICE:** to remove the broken levellers from tie rod using a drill.

**PROLEVELING WEDGE SYSTEM:** the leveling system with wedges improved in efficiency, ergonomics and in compliance with regulations, thanks to the fins directly fixed on the base.

**MULTISPACER:** patented multi-thickness spacer reusable over tile with the function of laying cross, T and linear in a single product.

### PROLEVELLING WEDGE SYSTEM



### MULTISPACER

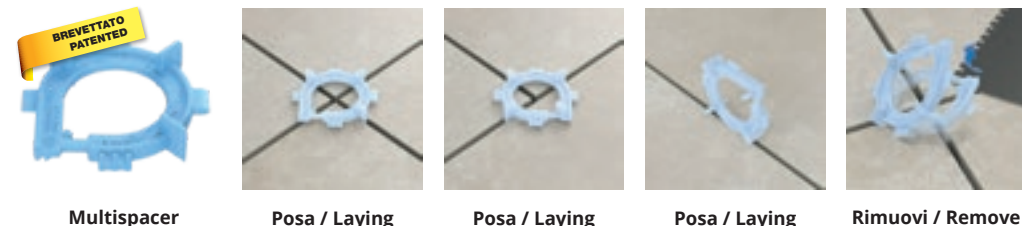

**BREVETTATO  
PATENTED**

**NEW**





# PROSUPPORT TUBE SYSTEM

**Il sistema più pratico, veloce e flessibile** per raggiungere l'altezza desiderata.

**PROSUPPORT TUBE SYSTEM** è un sistema di supporti modulari e regolabili per la realizzazione di pavimentazioni esterne sopraelevate di altezza variabile da 29 a 1000 mm. Il sistema è composto da 1 base, 2 viti, 1 ghiera, 2 teste e una serie di tubi per il raggiungimento dell'altezza desiderata. Le due teste, a seconda di come viene avvitata la vite, possono essere fisse o autolivellanti.



**The most practical, fast and flexible system** that reaches the desired height.

**PROSUPPORT TUBE SYSTEM** is an adjustable and modular supports system for outdoor floating floors from the height of 29 mm to 1000 mm. The system is composed of 1 base, 2 screws, 1 flange, 2 heads and several pvc pipes to obtain the requested height. Both heads, according to the screw, can be fix or self-leveling.



**BREVETTATO  
PATENTED**

# PRORAIL SYSTEM

**Infinite pose a regola d'arte** per ogni tipologia di pavimentazione esterna sopraelevata.

**PRORAIL SYSTEM** è un sistema modulare composto da travetti in alluminio per la posa di pavimenti sopraelevati di qualsiasi formato, che consente di realizzare sottostrutture stabili e modulari in combinazione con PROSUPPORT TUBE e PROSUPPORT SLIM. Il sistema si compone di due travetti in alluminio, PRORAIL e PRORAIL RET, di un anello di fissaggio PRORAIL RING, di due crocette distanziatrici con alette removibili PRORAIL SPACER e di una gomma antirumore e antiscivolo PRORAIL RUBBER.

**A workmanlike tiling anywhere, everywhere** for any type of outdoor raised flooring.

**PRORAIL SYSTEM** is a modular system composed of aluminium joists to lay floating floors of any size, to create steady and modular substructures together with PROSUPPORT TUBE and PROSUPPORT SLIM. The system consists of two aluminium joists, PRORAIL and PRORAIL RET, one fastening ring PRORAIL RING, two cross spacers with removable flaps PRORAIL SPACER and one anti-noise and anti-slip rubber PRORAIL RUBBER.

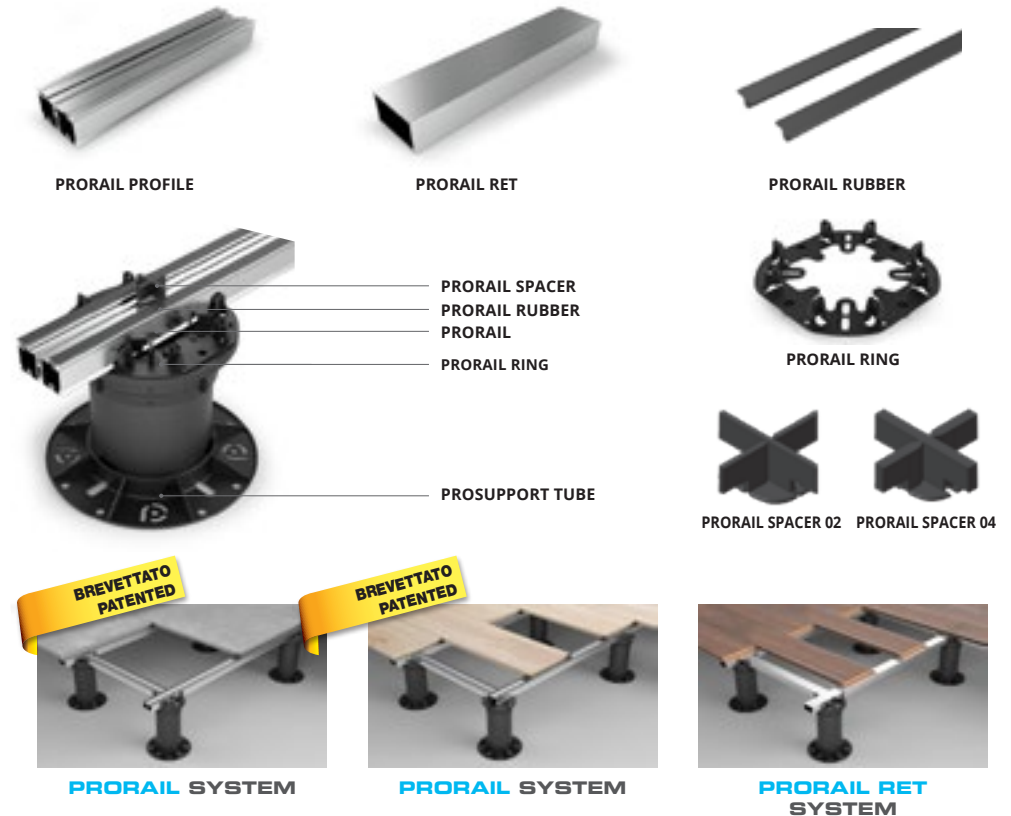

**BREVETTATO  
PATENTED**

# PROSUPPORT SLIM SYSTEM

## Massima sottigliezza, precisione al millimetro

L'evoluto sistema modulare per pavimenti esterni sopraelevati.

**PROSUPPORT TUBE SLIM** è un sistema di supporti modulari per la realizzazione di pavimentazioni esterne sopraelevate di altezza variabile da 10 a 40 mm, composto da due basi di altezza 10 mm, livellatori con spessore 2 mm e dischi antirumore e antiscivolo. Grazie alla sua modularità il sistema consente di realizzare, a partire da 10 mm, tutte le altezze con intervallo di 2 mm grazie ai livellatori.



## The thinnest result with a unique millimeter-precision

the advanced modular system for outdoor raised floors.

**PROSUPPORT TUBE SLIM** is a modular system to make outdoor floating floors from 10 to 40 mm height, it is composed of two bases of 10 mm height, levellers of 10 mm thickness and anti-noise and anti-slip disks. Thanks its modularity the system allows to make, from a height of 10 mm, all heights with 2 mm interval using the levellers.



BASE CON ALETTE 2 mm  
BASE WITH FLAPS 2 mm



BASE CON ALETTE 4 mm  
BASE WITH FLAPS 4 mm



LIVELLATORE  
LEVELLER



DISCO ANTI RUMORE - ANTI SCIVOLAMENTO  
ANTI-NOISE AND ANTI-SLIP DISK

### VANTAGGI:

- Posa sopraelevata da solo 1 cm a 4 cm;
- Estrema robustezza, stabilità e millimetrica regolazione;
- Con lo speciale anello PRORAIL RING è possibile ottenere strutture a travetti di basso spessore;

### ADVANTAGES:

- Floating Installation from 1 cm to 4 cm;
- Extreme strength, stability and millimetric adjustment;
- With the special PRORAIL RING it's possible to obtain very low thickness joists structures;

### ESEMPI DI POSA DI PROSUPPORT SLIM SYSTEM LAYING EXAMPLES OF PROSUPPORT SLIM SYSTEM

**ESEMPIO/EXAMPLE n1:**  
altezza finale 12 mm  
final height 12 mm



**ESEMPIO/EXAMPLE n2:**  
altezza finale 28 mm  
final height 28 mm



**ESEMPIO/EXAMPLE n3:**  
altezza finale 40 mm  
final height 40 mm





# PROLEDLIGHT SYSTEM

## L'arte di arredare sotto una nuova luce.

**PROLEDLIGHT SYSTEM** rappresenta l'innovativa linea LED di Progress Profiles comprensiva di profili per rivestimenti, profili per gradini e battiscopa, facili da installare e di grande pregio estetico destinati ad ambienti moderni e di tendenza dove un'atmosfera calda e suggestivi effetti ottici rivestono un ruolo di primo piano. Un sistema che reinventa il concetto di profilo mettendo in gioco l'elemento luminoso come brillante e inedita soluzione creativa per un nuovo modo di arredare e vivere lo spazio pubblico e privato, arricchendolo di personalità, dinamicità e di una suggestiva dimensione estetico-emozionale. Un progetto in puro stile contemporaneo, frutto di un'evolva ricerca e sviluppo svolta in stretta collaborazione con giovani e originali professionisti del mondo dell'architettura, per sperimentare nuove soluzioni capaci di soddisfare particolari e specifiche esigenze tecniche e di design nell'arredo creativo di ambienti pubblici e residenziali.

## The art of furnishing in a new light.

**PROLEDLIGHT SYSTEM** is the innovative LED range of Progress Profiles inclusive of profiles for walls, stairs and skirtings, easy to install and of great aesthetic value for modern environments, where a warm ambience and inspiring optical effects have an important role. A system that reinvents the concept of profile, and brings the element light into play as bright and new creative solution for a new way of fitting-out and live in private and public spaces in an aesthetic-emotional dimension. A project of contemporary style, result of an advanced research and development made with young professionals of the architecture world, to test new solutions and satisfy the technical needs of design and creative fitting-out of public and residential environments.



**PROSKIRTING GILED**

(In collaborazione con Arch.Gilberto Toneguzzi)  
Brevettato 280029 - Patented 3027825B1

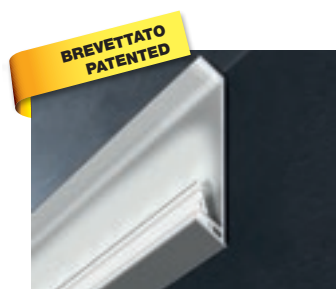

**PROSKIRTING LED**

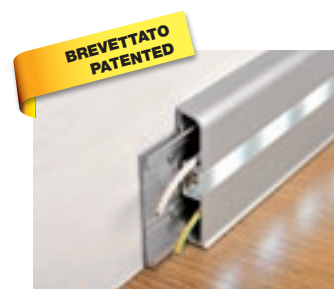

**PROLISTEL LED**

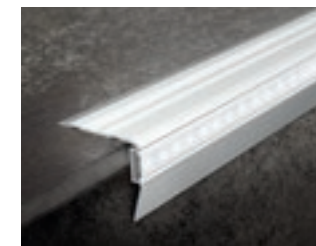

**PROSTAIR LED**

**BREVETTATO  
PATENTED**



# PROMULTIFIX SYSTEM

## Un prodotto, tante soluzioni

Si tratta di un sistema costituito da uno speciale TOP con adesivo con superficie a vista di 44,7 mm, in alluminio anodizzato o rivestito con pellicola effetto legno. Il Top in alluminio, può essere fissato al pavimento in diversi modi.

**Con adesivo:** il Top è provvisto su ambo i lati di un adesivo hotmelt che garantisce una forte adesione

**Con tasselli:** dopo aver forato il supporto ogni circa 50 cm con una punta da 6 mm ed aver infilato i tasselli nel Top, utilizzando un pezzo di legno ed un martello è possibile fissare il Top battendolo

**Supporto con piedini rimovibili:** dopo aver rimosso i piedini di altezza più elevata rispetto all'altezza desiderata, infilare il supporto nel Top, rimuovere la pellicola protettiva sottostante e posizionare il Top lungo il perimetro

**Base a schiacciamento:** dopo aver infilato il top nell'incastro della base a schiacciamento, premere con forza sino a quando il Top non si adagia sulla pavimentazione

Grazie al suo particolare design lo stesso Top, può essere utilizzato quindi sia per unire pavimenti allo stesso livello, per coprire giunti, per raccordare pavimenti a livelli diversi e per rifinire le pavimentazioni lungo i perimetri.

## One product for many solutions

It is a system composed by a special TOP with adhesive, with a visible surface of 44.7 mm, in anodized aluminium or covered with wood-effect film. The aluminium TOP can be fixed to the floor in different ways.

**With adhesive:** the Top is provided on both sides with a hotmelt adhesive that guarantees a strong adhesion.

**With nylon anchors:** after having drilled the support every about 50 cm with a 6 mm tip and having inserted the nylon anchors into the TOP, using a piece of wood and a hammer it is possible to fix the TOP by beating it.

**Support with removable spacers:** after removing the spacers in a height higher than the desired one, insert the support into the TOP, remove the protective film and place the TOP along the perimeter.

**"Flatten down Base":** after the insertion of the "flatten-down base" into the TOP, press firmly until the TOP lays down on the flooring.

Thanks to its particular design the TOP can be used to join floors at the same level, to cover joints, to connect floors to different levels and to finish the flooring along the perimeters.

Set accessori





2020/21



Sede /Headquarter

**Progress Profiles SpA**  
Via Le Marze 7  
31011 ASOLO (TV) Italy  
Tel. +39 0423 950398  
Fax +39 0423 950979  
Azienda certificata  
UNI EN ISO 9001:2015

[info@progressprofiles.com](mailto:info@progressprofiles.com)

Filiale /Branch Office & Warehouse

**Progress Profiles America Inc.**  
4 Middlebury Boulevard (Unit 14)  
Randolph, New Jersey 07869  
U.S.A  
Tel. 001 973 584 2650  
Fax 001 973 584 2657

[usa@progressprofiles.com](mailto:usa@progressprofiles.com)

Filiale /Branch Office & Warehouse

**Progress Profiles Middle East LLC**  
AL QUOZ INDUSTRIAL FOURTH  
26th Street, Showroom No. 1  
Dubai, U.A.E.  
Tel. 00971-04 325 1499  
Fax 00971-04 325 1466  
P.O. BOX: 29101

[uae@progressprofiles.com](mailto:uae@progressprofiles.com)

Filiale /Branch Office & Warehouse

**Progress Profiles Oceania Pty Ltd**  
*Melbourne:* PO Box 8 - L1  
64 Sutton Street  
North Melbourne VIC 3051  
*Sydney:* 81-187 Cowpasture Road  
Wetherill Park NSW 2164

AUSTRALIA  
Office +61 3 9888 7263  
[ppo@progressprofiles.com](mailto:ppo@progressprofiles.com)



Available on the  
App Store

GET IT ON  
Google Play



**35**  
ANNIVERSARY 1985-2020